

Dimplex

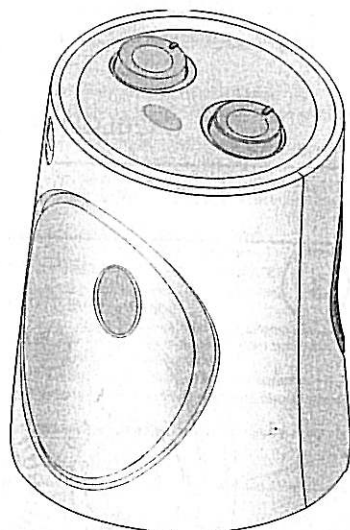

C120TLS
C120TLSS

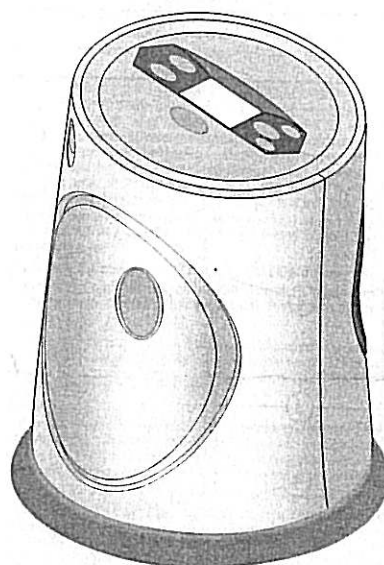

C120LCD
C120LCDS

AUS/NZ

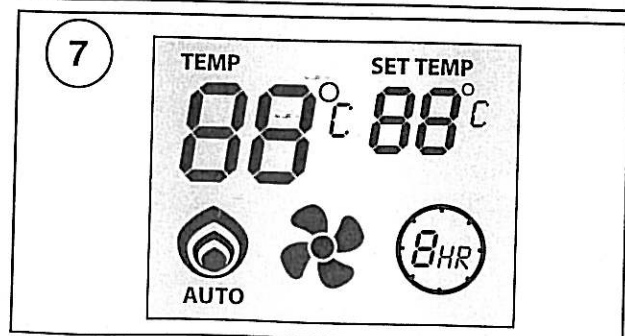
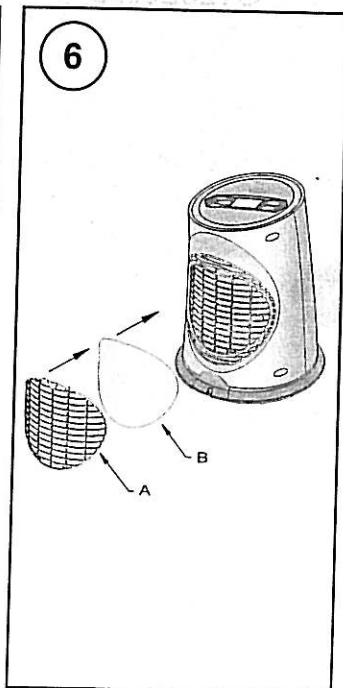
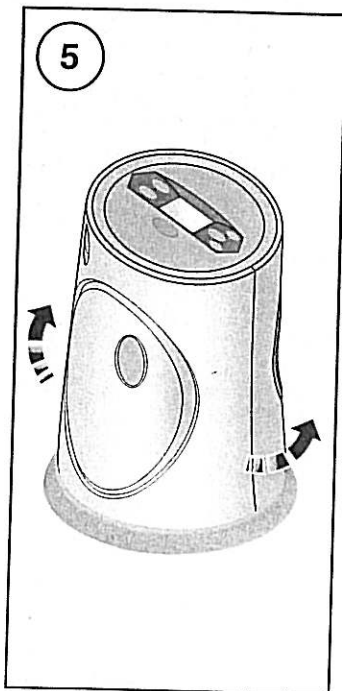
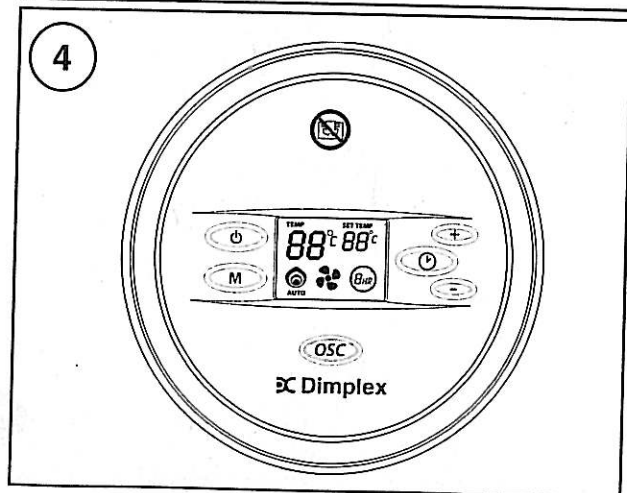
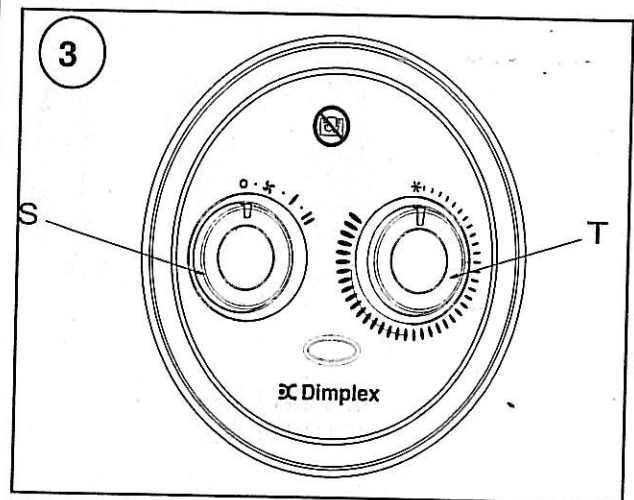
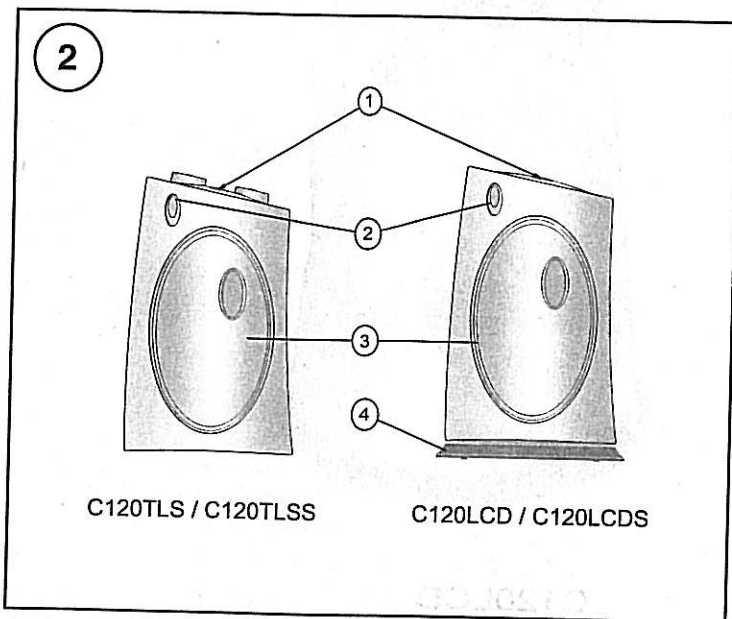
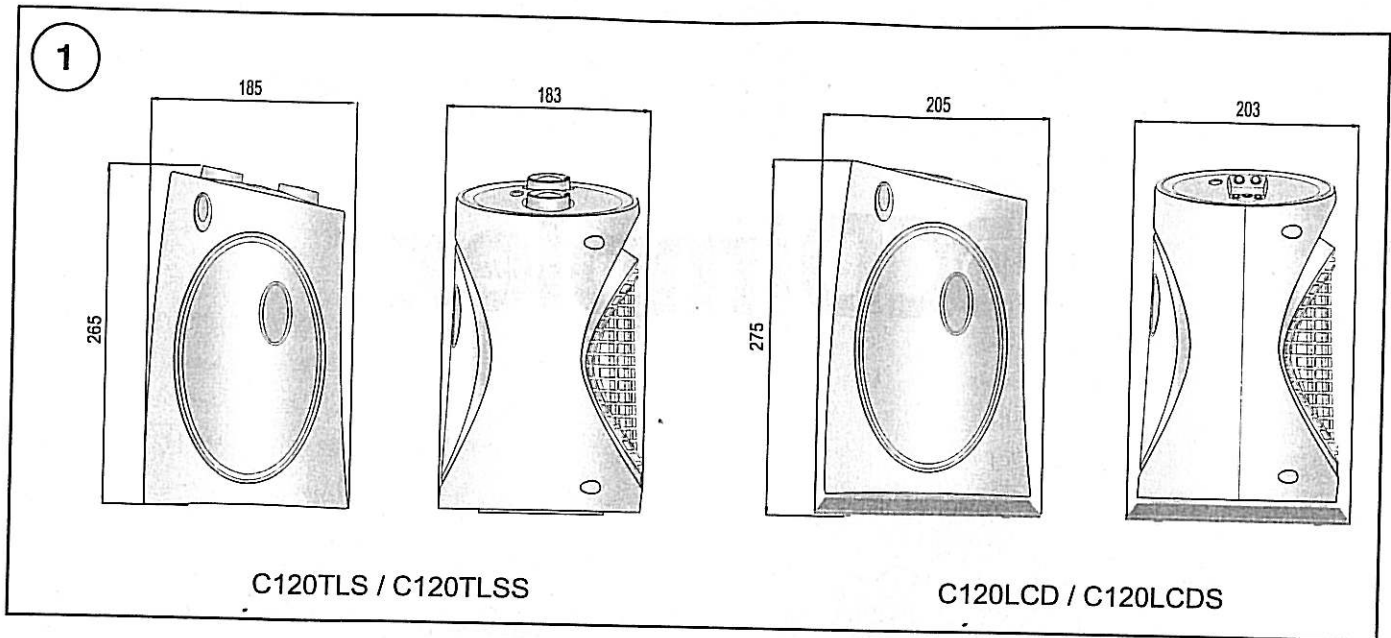

C120TLS, C120TLSS, C120LCD & C120LCDS Ceramic Heaters

THESE INSTRUCTIONS SHOULD BE READ CAREFULLY AND RETAINED FOR FUTURE REFERENCE

Dear Customer,

Please read the following information carefully before using the appliance for the first time for your own safety and to ensure correct use.

Attention! The appliance may only be used for normal domestic use and not for industrial purposes.

IMPORTANT SAFETY ADVICE

- The appliance must only be used as described in the instructions for use! Use for any other purpose is forbidden! Any damage resulting from improper use and non-observance of the safety information will invalidate any liability and warranty!
- All liability is disclaimed for any frost damage caused by a heating capacity that is insufficient for the room size, bad heat insulation of the room, incorrect use or force majeure (e.g. power failure).
- Only connect the appliance to A.C. mains as specified on the rating plate!
- Never touch live parts! **Danger to life!**
- Never operate the appliance with wet hands! **Danger to life!**
- The appliance must be placed in a way that the control elements cannot be touched by persons who are in bath, shower, or any other water-filled receptacle.
- Do not use the appliance in rooms with bath, shower or swimming pool or in the vicinity of wash basins or water connections!
- Do not expose the appliance to rain or other moisture! The appliance is not for outdoor use. The appliance must only be stored indoors!
- Never use the appliance if the appliance or cord is damaged. **Risk of Injury!**
- Check the power cord regularly for damage.
- If the power cord or if the appliance is damaged to the extent that electrical parts are exposed, disconnect it immediately from the mains and see your authorised retailer!
- Improper repairs can expose the user to considerable danger.
- The appliance may only be opened up and repaired by authorised qualified personnel.
- Do not store or use any flammable materials or sprays in the vicinity of the appliance when the appliance is in use. **Fire hazard!**
- Do not use the appliance in flammable atmospheres (e.g. in the vicinity of combustible gases or spray cans)! **Explosion and fire hazard!**
- The appliance should not be used in areas which are a fire risk, such as garages, stables, or wooden sheds.
- Important!** Do not insert any foreign objects into the appliance openings! **Risk of Injury** (electric shock) and damage to the appliance!
- The appliance air inlet and outlet openings must not be obstructed in any way!
- Place the appliance so that it cannot be touched by accident. **Risk of burns!**
- WARNING: IN ORDER TO AVOID OVERHEATING, DO NOT COVER THE HEATER.**
- The heater carries the Warning symbol  indicating that it must not be covered.
- The appliance is not suitable for connection to permanent wiring!
- This appliance is not intended for use by persons (including children) with reduced physical, sensory or mental capabilities, or lack of experience and knowledge, unless they have been given supervision or instruction concerning use of the appliance by a person responsible for their safety.
- Young children should be supervised to ensure that they do not play with the appliance!
- The socket-outlet must be accessible at all times to enable the mains plug to be disconnected as quickly as possible!
- Attention!** To avoid any danger due to unintentionally resetting the thermal cut-out, the appliance must not be supplied via a timer.
- The appliance is not suitable for animal breeding purposes!
- The instruction leaflet belongs to the appliance and must be kept in a safe place. When changing owners, the leaflet must be surrendered to the new owner!

IMPORTANT – If the mains lead of this appliance is damaged, it must be replaced by the manufacturer or its service agent or a similarly qualified person in order to avoid a hazard.

Packaging

- After unpacking the appliance, check the same for transport damage and the contents for completeness! In the event of damage or an incomplete delivery, contact your authorised retailer!
- Do not discard the original box! It can be used for storage and dispatch to avoid transport damage!
- Dispose of the packaging material in a proper manner! Plastic bags should be kept away from children!

Location

- The appliance should be placed with a minimum distance of 50cm from flammable objects, walls or other structures! The appliance openings must not be obstructed in any way!
- Do not place the appliance on instable surfaces (e.g. a bed), where it can tip over!
- The appliance must not be located below a socket outlet!
- The appliance must not be operated directly on high pile carpets.

Power cord

- Only use an approved extension cord that is suitable for the appliance rating!
- Position the power cord so that it does not pose a tripping hazard and possibly cause the appliance to be knocked over.
- The power cord must not come into contact with hot appliance parts!
- Never pull the plug out of the socket at the cord!
- Never move the appliance by pulling at the cord or use the cord for carrying purposes!
- Do not coil the cord around the appliance! Do not use the appliance with the cord coiled!
- This applies particularly if a cable drum is used.
- Do not crush the cord or drag it over sharp edges. Do not place it over heated hotplates or naked flames!

Start up

- After switching on the appliance for the first time and after an extended period of non-use, a smell may be noticed for a short time.
- To use, insert the plug in the socket.

Operation – C120TLS & C120TLSS models

Switch (S) – see Fig. 3

With the selector switch, the fan can be switched on or the heat setting selected. The power indicating light illuminates (see '2' in Fig. 2) when the Switch (S) is turned on.

Thermostat (T) – see Fig. 3

In order to maintain a certain room temperature, set the controller to 'max.'. Operate the appliance at full power until the required room temperature is reached. Set back the thermostatic controller until the appliance switches off with an audible 'click'. This temperature will be kept almost constant by the thermostatic control switching on and off automatically. Please note that the appliance can only be switched on when the thermostat setting is higher than the room temperature.

With the control knob (T) set to  and the control knob (S) set to the required heating output the appliance switches on automatically when the temperature falls below +5°C...+8°C.

Operation – C120LCD & C120LCDS models

The heat output is controlled electronically, according to the room temperature. When the unit is plugged in the power light illuminates (see '2' in Fig. 2). The unit is now in stand by mode. The power light will remain lit until the heater is disconnected from the power outlet.

Table 1













	Stand by button
	Mode button
	Oscillation button
	Timer button
	Up button
	Down button

Table 2

	Fan symbol
	Low heat mode
	High heat mode
	Auto heat mode
	Timer symbol
	Air Temperature symbol
	Set Temperature symbol

Pressing the Stand by button see Table 1 and Fig 4 will start the heater. Pressing the Stand by button again will return the heater to stand by mode. Upon turning the heater on, the unit will be in Auto heating mode with a set temperature of 35°C. The set temperature, heating mode and fan icons appear on the display – see Table 2 and Fig. 7. The current air temperature will also appear on the display. The display is back lit and to conserve energy the back light will turn off after 15 seconds if no control buttons have been pressed. If the Mode, Oscillating or Timer button (see Table 1 and Fig. 4) is pressed, the back light will turn on again.

In Auto heating mode the set temperature can be adjusted as desired using the Up/Down buttons (see Table 1 and Fig. 4), located on the control panel. Pressing the Mode button selects the heating mode. Pressing the Mode button will cycle the heater through the heating modes Auto mode/Fan only/Low heat/High heat. By pressing this button once Fan only mode is selected, pressing twice provides Low heat mode, pressing three times High heat mode is selected. Pressing the Mode button once more returns the heater to Auto heat mode. When the heater is in Low heat, High heat or Fan only mode the current air temperature will appear on the display, the set temperature indicator will not be displayed – see Table 2 and Fig. 7.

Note: If switched to stand by mode the heater will retain its last heat setting. The last heat setting will be cleared from memory once the heater is disconnected from the power outlet.

Thermostat

Press the Mode button until the display shows Auto heat mode – see Table 2 and Fig. 4. To adjust the set temperature, press "+" to increase the temperature and "-" to decrease the temperature – see Table 1 and Fig. 4. The set temperature can be adjusted from 5°C to 35°C and this will be shown on the display. When the air temperature rises above the set temperature, the heat will switch off but the fan will continue to run for approximately 20 seconds. When the air temperature drops below the set temperature, the unit will come back on.

Note: When in heating mode if the unit is set to stand by mode the fan will continue to run for approximately 20 seconds.

Runback Timer Mode – C120LCD & C120LCDS models only

The heater is fitted with a run-back timer feature which can be set in any of the operating modes – Auto, Fan only, Low heat or High heat mode. The run time can be set by pressing the Timer button – see Table 1 and Fig. 4. If the Timer symbol (see Table 2) is not shown pressing the Timer button once activates timer mode and "TH" will appear on the display – see Fig. 4. Pressing the Timer button again will advance the set running time to "2HH" and this will appear on the display. If the timer button is pressed and held the hour display continues to count up until "8HH" appears on the display. At this point releasing and pressing the Timer button again will deactivate the timer mode and the Timer symbol will disappear from the display but the heater will continue to run. Once the run time has been set the heater will run and the Timer symbol will remain on the display until the set time runs out. At this point the heater will switch to stand by mode. To turn the heater back on, press the Stand by button.

Oscillating Function – C120LCD & C120LCDS models only – see Fig. 5

This heater is provided with an oscillating function. When the Oscillation button is pressed (see Table 1 and Fig. 4) the heater will oscillate back and forth. Press the Oscillation button again and the oscillation will stop.

Safety Cut-out

The heater is fitted with a thermal cut-out. If the air inlet or outlet grilles are restricted in anyway the cut-out switches the heater off automatically. To bring the heater back into operation, remove the cause of over heating then unplug the unit from the electrically supply for a few minutes. When the heater has cooled sufficiently reconnect and switch on the heater.

Fuse Link

A thermal fuse link is provided as an added safety feature. If the fuse link operates and opens circuit it is the result of abnormal overheating within the appliance and servicing of the appliance by a competent service engineer will be required in order to ensure the future safe operation of the heater. Customer services should be contacted, who will arrange the replacement of any faulty parts and the fitting of a new fuse link.

Air Filter – C120LCD & C120LCDS models only – see Fig. 6

This heater is provided with an air filter. Dust and fluff can accumulate in the filter and to avoid overheating of the element the filter should be cleaned when required. To clean the filter remove the filter bracket from the back of the heater – see 'A' in Fig. 6. The filter (see 'B' in Fig. 6) can be taken from the filter bracket and dust or fluff can then be removed using a vacuum cleaner. When cleaning of the filter is complete the filter should be refitted to the filter bracket. The filter bracket should then be refitted to the rear of the product.

Note: Disconnect the heater from the power supply before cleaning the filter.

Transport

The appliance is provided with a handle for easy carrying

Cleaning

Switch off the appliance first and disconnect the plug from the socket! Clean the housing with a moist cloth, vacuum cleaner or brush. Do not use any abrasive or caustic cleaning agents! Do not use any flammable cleaning agents e.g. petrol or spirit for cleaning the appliance. Never immerse the appliance in water! **Danger to life!** Air inlet- and outlet area should be cleaned with a vacuum cleaner regularly. If the appliance is not used for extended periods, it must be protected against excessive dust and dirt.

Storage

Store the heater with these instructions in the original carton in a cool, dry place.

Disposal

Old appliances should be taken to a public refuse collection point for proper disposal! Worn out appliances must be made unusable by cutting through the power cord

After Sales Service

Please see the separate Warranty leaflet for details of your Warranty and After Sales Service including contact details.

Should you require after sales service, please get in touch with the supplier through whom you purchased the appliance, or the contract number on your Warranty leaflet.